

User's Guide Specification

담당	관리자
SHIN HJ 09.02.04	KIM JO 09.02.04

1. Model Description

MODEL	32/37/42/47LH7000-ZA	BRAND	LG	Part No.	MFL41425833 (0904-REV03)
SUFFIX	EK	Product Name	32/37/42/47LH70**		

2. Printing Specification

1. Trim Size (Format) : 185 mm x 260 mm
2. Printing Colors : 1 Color (BLACK)
3. Stock (Paper) : Uncoated paper, 백상지 60 g/㎡
4. Printing Method : Off-set
5. Bindery : Saddle stitch
6. Language : EN (1)
7. Number of pages : 16 pages

NOTES

"This part contain Eco-hazardous substances (Pb, Cd, Hg, Cr6+, PBB, PBDE, etc.) within LG standard level, Details should be followed Eco-SCM management standard[LG(56)-A-2524]. Especially, Part should be followed and controlled the following specification.
 (1) Eco-hazardous substances test report should be submitted when Part certification test and First Mass Production.
 (2) Especially, Don't use or contain lead(Pb) and cadmium(Cd) in ink.

3. Special Instructions

(1) Origin Notification

- * LGEIN : Printed in Indonesia
- * LGEWA : Printed in U.K.
- * LGEMA : Printed in Poland
- * LGESP : Printed in Brazil
- * LGEMX : Printed in Mexico
- * LGEND : Printed in China
- * LGEIL : Printed in India
- * Other Oversea Factories : NON

3. Changes

10				
9				
8				
7				
6				
5				
4				
3	04/20/09	Shin Hye Jung	S9-50428	Added 32/37/42LG2100-ZA models.
2	03/30/09	Shin Hye Jung	S9-48133	Added LF2510-ZB & Changed Drawing for LU40 **
1	02/10/09	SHIN.H.J.	S9-42817	Amended picture for Stand Rear Cover of LH70**
REV. NO.	MM/DD/YY	SIGNATURE	CHANGE NO.	CHANGE CONTENTS

Pagination sheet

P/NO. **MFL41425833**

Total pages : 16 pages

Front Cover (EN) P/NO.	2	3	4	...	16
-------------------------------------	---	---	---	-----	----



LG
Life's Good

LCD TV OWNER'S MANUAL

DVB
Digital Video
Broadcasting

Trade Mark of the DVB Digital Video
Broadcasting Project (1991 to 1996)

ID Number(s): 6337 : 19LU4000 6484 : 32LH5000
 6423 : 19LU4010 6455 : 32LH5020
 6338 : 22LU4000 6459 : 32LH5010
 6424 : 22LU4010 6485 : 37LH5000
 6334 : 19LU5000 6456 : 37LH5020
 6428 : 19LU5010 6460 : 37LH5010
 6425 : 19LU5020 6486 : 42LH5000
 6335 : 22LU5000 6457 : 42LH5020
 6429 : 22LU5010 6461 : 42LH5010
 6426 : 22LU5020 6487 : 47LH5000
 6336 : 26LU5000 6458 : 47LH5020
 6430 : 26LU5010 6462 : 47LH5010
 6427 : 26LU5020 6195 : 32LH7000
 6200 : 19LH2000 6529 : 32LH7010
 6437 : 19LH2010 6475 : 32LH7020
 6431 : 19LH2020 6471 : 32LH7030
 6201 : 22LH2000 6196 : 37LH7000
 6438 : 22LH2010 6479 : 37LH7010
 6432 : 22LH2020 6476 : 37LH7020
 6202 : 26LH2000 6472 : 37LH7030
 6439 : 26LH2010 6197 : 42LH7000
 6433 : 26LH2020 6528 : 42LH7010
 6203 : 32LH2000 6477 : 42LH7020
 6440 : 32LH2010 6473 : 42LH7030
 6434 : 32LH2020 6198 : 47LH7000
 6204 : 37LH2000 6480 : 47LH7010
 6441 : 37LH2010 6478 : 47LH7020
 6435 : 37LH2020 6474 : 47LH7030
 6205 : 42LH2000 6481 : 32LF2500
 6442 : 42LH2010 6618 : 32LF2510
 6436 : 42LH2020 6482 : 37LF2500
 6206 : 32LH3000 6617 : 37LF2510
 6451 : 32LH3010 6483 : 42LF2500
 6447 : 32LH3020 6616 : 42LF2510
 6443 : 32LH3030 6488 : 32LH4900
 6208 : 37LH3000 6489 : 37LH4900
 6452 : 37LH3010 6490 : 42LH4900
 6448 : 37LH3020 6491 : 47LH4900
 6444 : 37LH3030 6755 : 32LG2100
 6209 : 42LH3000 6756 : 37LG2100
 6453 : 42LH3010 6757 : 42LG2100
 6449 : 42LH3020
 6445 : 42LH3030
 6210 : 47LH3000
 6454 : 47LH3010
 6450 : 47LH3020
 6446 : 47LH3030
 6211 : 32LH4000
 6467 : 32LH4020
 6463 : 32LH4010
 6212 : 37LH4000
 6468 : 37LH4020
 6464 : 37LH4010
 6213 : 42LH4000
 6469 : 42LH4020
 6465 : 42LH4010
 6214 : 47LH4000
 6470 : 47LH4020
 6466 : 47LH4010

19LU40** 32LH50**
 22LU40** 37LH50**
 19LU50** 42LH50**
 22LU50** 47LH50**
 26LU50** 32LH70**
 19LH20** 37LH70**
 22LH20** 42LH70**
 26LH20** 47LH70**
 32LH20** 32LF25**
 37LH20** 37LF25**
 42LH20** 42LF25**
 32LH30** 32LH49**
 37LH30** 37LH49**
 42LH30** 42LH49**
 47LH30** 47LH49**
 32LH40** 32LG21**
 37LH40** 37LG21**
 42LH40** 42LG21**
 47LH40**

Please read this manual carefully before operating your TV. Retain it for future reference. Record the model number and serial number of the TV. Refer to the label on the back cover and quote this information. To your dealer when requiring any service.

An extended Owner's Manual that contains information on the advanced features of these LG TV sets is located on the CD- ROM provided in an electronic version.

To read these files, you will need to use a Personal Computer (PC) equipped with a CD- ROM drive.





This product qualifies for ENERGY STAR in the "factory default (Home Use mode)" setting and this is the setting in which power savings will be achieved. Changing the factory default picture setting or enabling other features will increase power consumption that could exceed the limits necessary to qualify for Energy Star rating.

P/NO: MFL41425833 (0904-REV03)
Printed in Korea

SAFETY INSTRUCTIONS

- Please read these safety precautions carefully before using the product.
- In this manual, the illustration may be somewhat different from your product because it is just example to help the instruction.

-  **WARNING** If you ignore the warning message, you may be seriously injured or there is a possibility of accident or death.
-  **CAUTION** If you ignore the caution message, you may be slightly injured or the product may be damaged.

Precaution in Installing the Product

WARNING

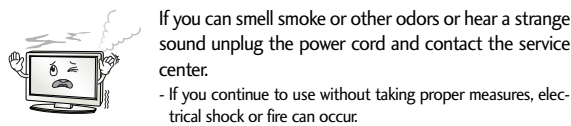
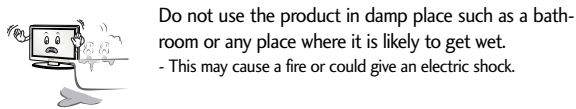
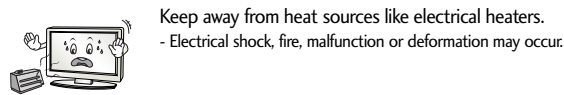

CAUTION

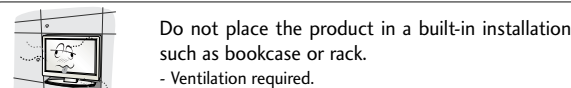
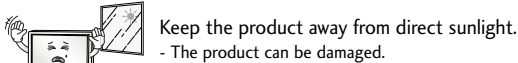
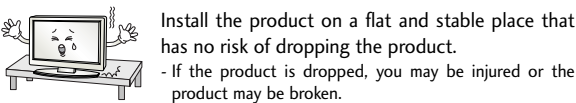

Electrical Power Related Precautions

WARNING

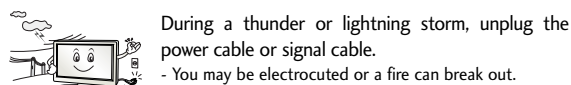
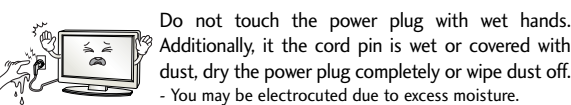
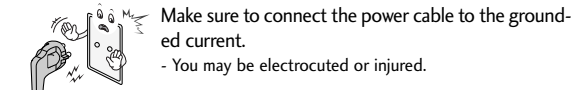

CAUTION

Protect the power cord from physical or mechanical abuse, such as being twisted, kinked, pinched, closed in a door, or walked upon. Pay particular attention to plugs, wall outlets, and the point where the cord exits the appliance.



As long as this unit is connected to the AC wall outlet, it is not disconnected from the AC power source even if you turn off this unit by SWITCH.

Precautions in Moving the Product

WARNING

Make sure to turn off the product.
Make sure to remove all cables before moving the product.
- You may be electrocuted or the product can be damaged.



CAUTION

Do not shock the product when moving it.
- You may be electrocuted or the product can be damaged.
Make the panel face forward and hold it with both hands to move.
- If you drop the product, the damaged product can cause electric shock or fire. Contact with the service center for repair.



Precautions in Using the Product

WARNING

Do not disassemble, repair or modify the product at your own discretion.
- Fire or electric shock accident can occur.
- Contact the service center for check, calibration or repair.



To reduce the risk of fire or electric shock, do not expose this apparatus to rain or moisture. Apparatus shall not be exposed to dripping or splashing and no objects filled with liquids, such as vases, shall be placed on the apparatus.



Refer all servicing to qualified service personnel. Servicing is required when the apparatus has been damaged in any way, such as power supply cord or plug is damaged, liquid has been spilled or objects have fallen into the apparatus, the apparatus has been exposed to rain or moisture, does not operate normally, or has been dropped.



IMPORTANT INFORMATION TO PREVENT "IMAGE BURN / BURN-IN" ON YOUR TELEVISION SCREEN

- When a fixed image (e.g. logos, screen menus, video game, computer display and teletext pages) is displayed on the television for an extended period it can become permanently imprinted on the screen. This phenomenon is known as "image burn" or "burn-in". Image burn is not covered under the manufacturer's warranty.
- In order to prevent image burn, avoid displaying a fixed image on your television's screen for a prolonged period (2 or more hours for LCD, 1 or more hours for Plasma).
- Image burn can also occur on the letterboxed areas of your television if you use the 4:3 aspect ratio setting for an extended period.

PREPARATION

Ensure that the following accessories are included with your TV. If an accessory is missing, please contact the dealer where you purchased the TV.

- Image shown may differ from your TV.

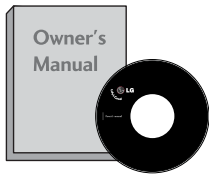

Owner's Manual

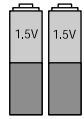

Batteries

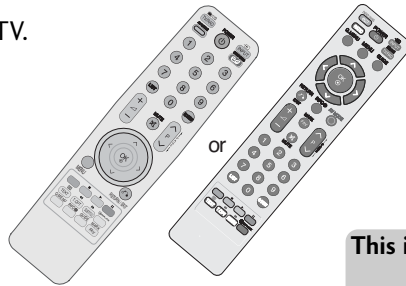

Remote Control



Ferrite Core
(This item is not included for all models.)



Power Cord

This item is not included for all models.

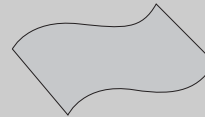

Polishing Cloth
Polishing cloth for use on the screen.

* Lightly wipe any stains or fingerprints on the surface of the TV with the polishing cloth.

Do not use excessive force. This may cause scratching or discoloration.



Cable management clip
(Only 32/37/42/47LH70**) (Refer to p.10)

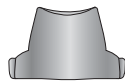

Stand rear cover
(Only 37/42/47LH70**) (Refer to p.8)

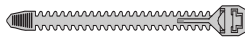

Cable Holder
(Only 19/22LU40**, 19/22/26LU50**) (Refer to p.9)



Cable management clip
(Only 19/22LH20**) (Refer to p.9)



1-screw for stand fixing
(Only 26LU50**, 32/37/42LF25**, 32/37/42LG21**, 26/32/37/42LH20**, 32/37/42LH30**, 32/37/42LH40**, 32/37/42LH49**, 32/37/42LH50**, 32/37LH70**) (Refer to p.7)

Bolts for stand assembly
(Refer to p. 4~6)



x 4

(Only 32/37/42LF25**, 32/37/42LG21**, 26/32/37/42LH20**, 32/37/42/47LH30**, 32/37/42/47LH40**, 32/37/42/47LH49**, 32/37/42/47LH50**) (Only 19/22LU40**)



x 4

(Only 32/37/42LF25**, 32/37/42LG21**) (Only 19/22LU50**)



x 2

(Only 19/22LU50**)



x 3

(Only 26LU50**)



x 7

M4x20 (Only 32LH70**)



x 8

M4x20 (Only 37LH70**)



x 8

M4x16 (Only 47LH70**)



x 3

M4x20 (Only 42LH70**)



x 4

M4x16 (Only 42LH70**)



x 5

(Only 19/22LU40**)

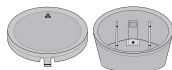

Stand Rear Body Cap
(Only 19/22LU40**) (Refer to p.6)

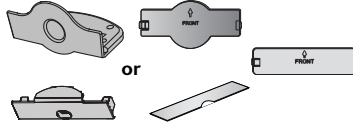

Protection Cover
(Except for 19/22LU40**, 19/22/26LU50**) (Refer to p.11)

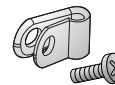

Protective Bracket and Bolt for Power Cord
(Only 32/37/42/47LH70**) (Refer to p.10)



USB extension cable
(Only 32/37/42/47LH70**) Make sure to use the provided USB extension cable, which is specially designed for a slim fit.

Use screws 12mm(+0.5/-0.5) long on the SET assembly side.
(Only 42/47LH70**)

Set assembly side
(with guide spacer)

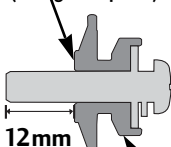

12mm

Guide spacer

Set assembly side
(without guide spacer)

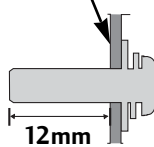

12mm

PREPARATION

STAND INSTALLATION

■ Image shown may differ from your TV

When assembling the desk type stand, check whether the bolt is fully tightened. (If not tightened fully, the product can tilt forward after the product installation.) If you tighten the bolt with excessive force, the bolt can deviate from abrasion of the tightening part of the bolt.

Only 32/37/42/47LH70**

- 1 Carefully place the TV screen side down on a cushioned surface to protect the screen from damage.

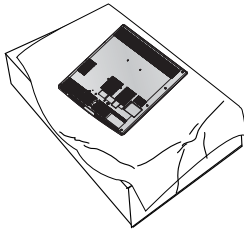

- 2 Assemble the parts of the **Stand Body** with the **Stand Base** of the TV.

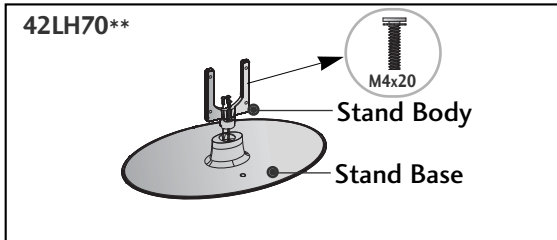
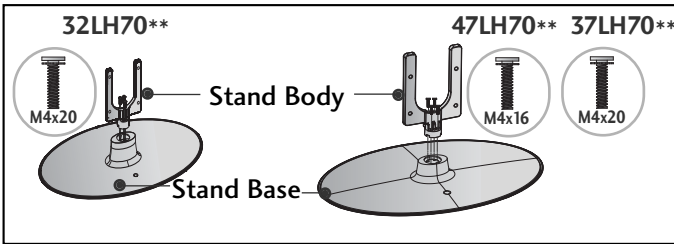

- 3 Assemble the TV as shown.

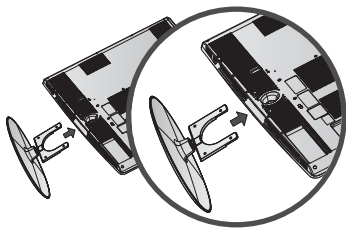

- 4 Fix the 4 bolts securely using the holes in the back of the TV.

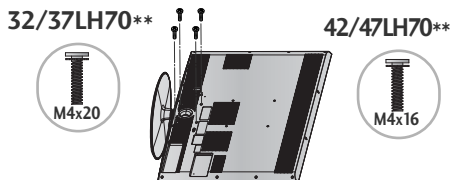

Only 26/32/37/42LH20**,
32/37/42/47LH30**, 32/37/42/47LH40**,
32/37/42/47LH49**, 32/37/42/47LH50**

- 1 Carefully place the TV screen side down on a cushioned surface to protect the screen from damage.

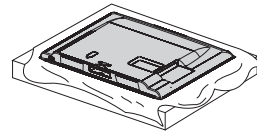

- 2 Assemble the TV as shown.

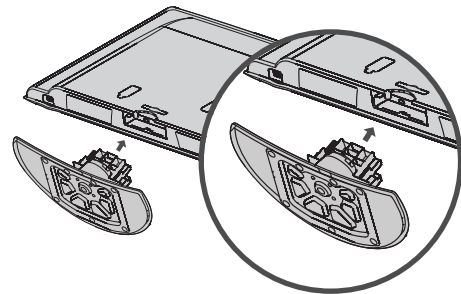

- 3 Fix the 4 bolts securely using the holes in the back of the TV.

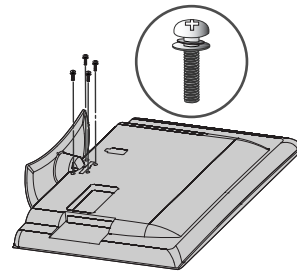

Only 19/22LH20**

- 1 Carefully place the TV screen side down on a cushioned surface to protect the screen from damage.

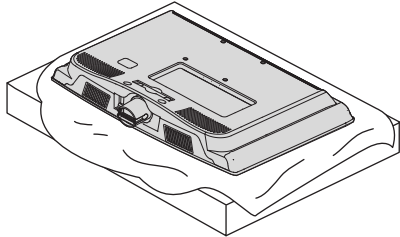

- 2 Assemble the TV as shown.

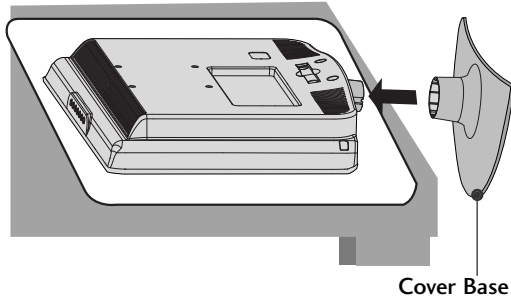

Only 19/22/26LU50**

- 1 Carefully place the TV screen side down on a cushioned surface to protect the screen from damage.

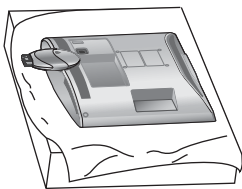

- 2 Fix the 2 or 3 bolts securely using the holes.

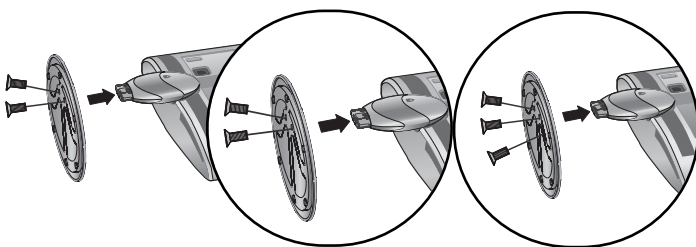

(Only 26LU50**)

Only 32/37/42LF25,
32/37/42LG21****

- 1 Carefully place the TV screen side down on a cushioned surface to protect the screen from damage.

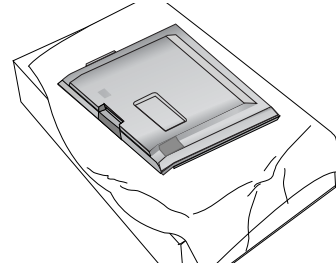

- 2 Assemble the parts of the **Stand Body** with the **Cover Base** of the TV.

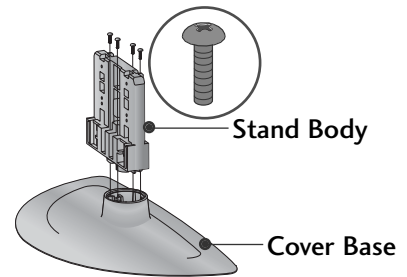

- 3 Assemble the TV as shown.

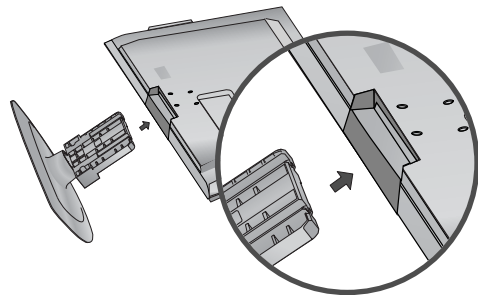

- 4 Fix the 4 bolts securely using the holes in the back of the TV.

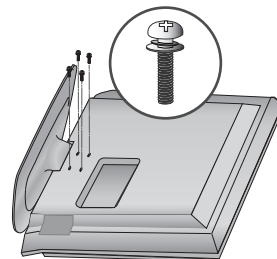

PREPARATION

Only 19/22LU40**

- 1 Carefully place the TV screen side down on a cushioned surface to protect the screen from damage.

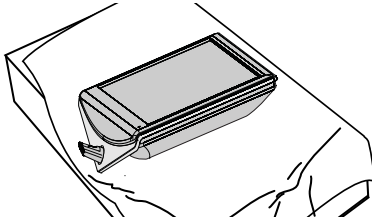

- 2 Fix the 3 bolts securely using the holes in the Cover Base.

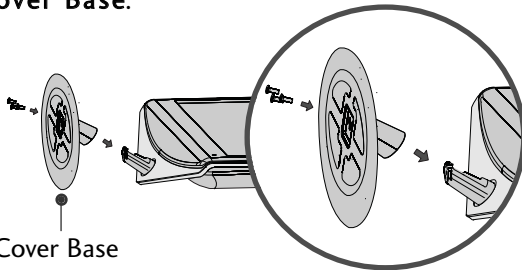

Cover Base

- 3 Assemble the parts of the Stand Rear Body with the TV.

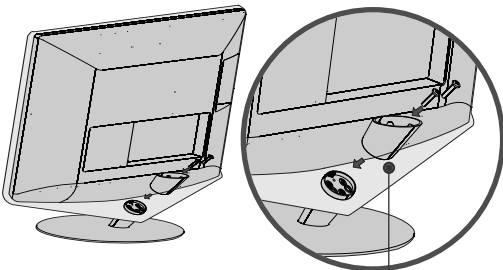

Stand Rear Body

- 4 Assemble the parts of the Cap with the Stand Rear Body of the TV.

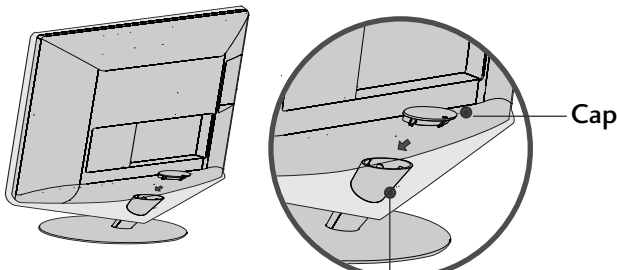

Cap

Stand Rear Body

DETACHING STAND

Image shown may differ from your TV.

Only 19/22LU40**

- 1 Carefully place the TV screen side down on a cushioned surface to protect the screen from damage.

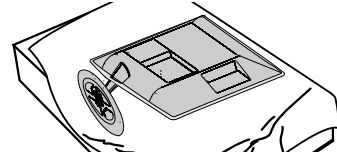

- 2 Detach the Cap from TV. Press in the direction of the arrow to detach the cap.

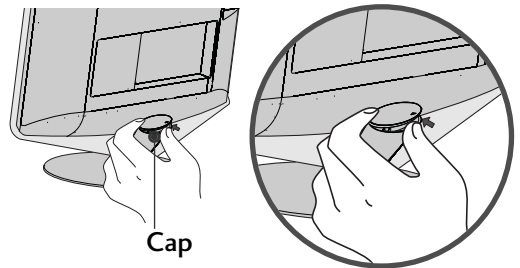

Cap

- 3 Loosen the bolts and then detach the Stand Rear Body from TV.

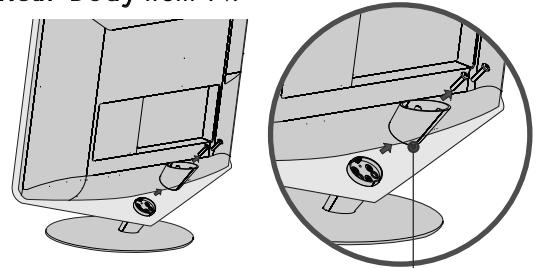

Stand Rear Body

- 4 Loosen the bolts and then detach the Cover Base from TV.

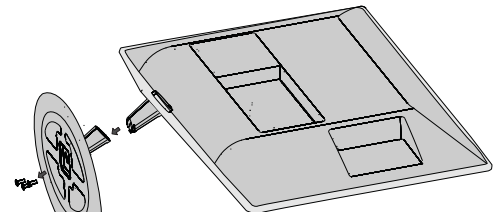

Cover Base

- 5 Loosen the bolts and then detach the Stand Body from TV.

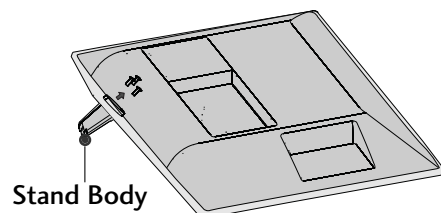

Stand Body

Only 19/22/26LU50**

- 1 Carefully place the TV screen side down on a cushioned surface to protect the screen from damage.

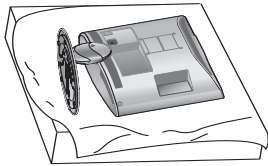

- 2 Loosen the bolts and then detach the stand from TV.

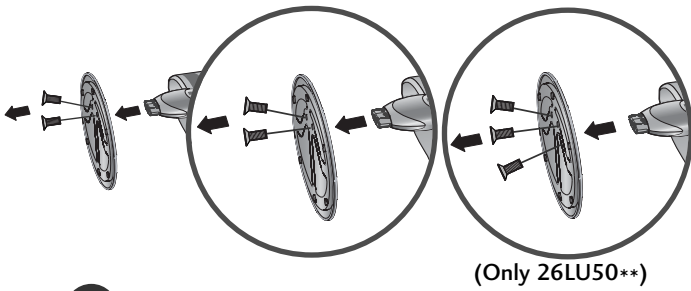

- 3 Loosen the bolts from TV.
Detach the **Cover Base** from TV.

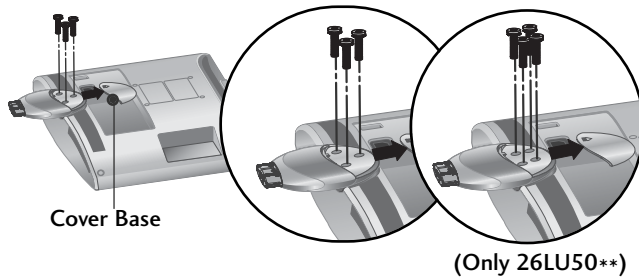

- 4 Detach the **Stand Body** from TV.

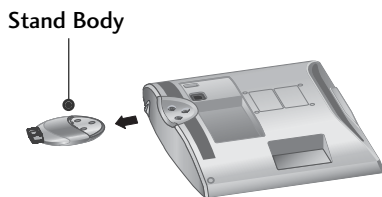

ATTACHING THE TV TO A DESK

(Only 26LU50**, 32/37/42LF25**, 32/37/42LG21 **, 26/32/37/42LH20**, 32/37/42LH30**, 32/37/42LH40**, 32/37/42LH49**, 32/37/42LH50**, 32/37LH70**)

■ Image shown may differ from your TV.
The TV must be attached to desk so it cannot be pulled in a forward/backward direction, potentially causing injury or damaging the product. Use only an attached screw.

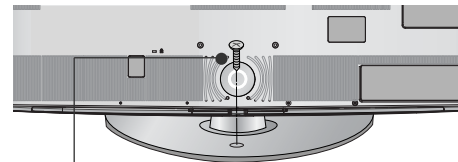

1-Screw
(provided as parts of the product)

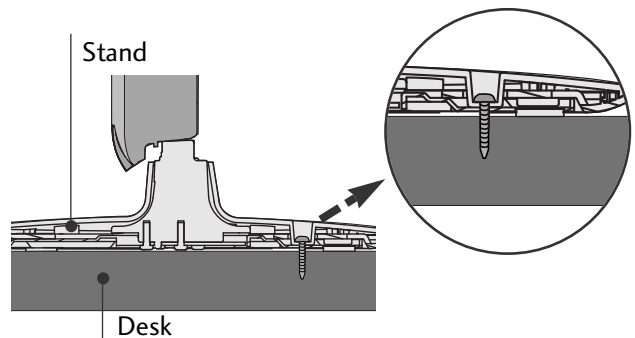

! WARNING

▶ To prevent TV from falling over, the TV should be securely attached to the floor/wall per installation instructions. Tipping, shaking, or rocking the machine may cause injury.

DESKTOP PEDESTAL INSTALLATION

For adequate ventilation allow a clearance of 4" (10cm) all around the TV.

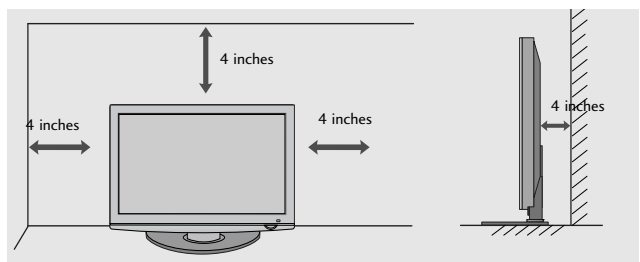

PREPARATION

CAREFUL INSTALLATION ADVICE

- You should purchase necessary components to fix the TV safely and secure to the wall on the market.
- Position the TV close to the wall to avoid the possibility of it falling when pushed.
- The instructions shown below are a safer way to set up the TV, by fixing it to the wall, avoiding the possibility of it falling forwards if pulled. This will prevent the TV from falling forward and causing injury. This will also prevent the TV from damage. Ensure that children do not climb or hang from the TV.

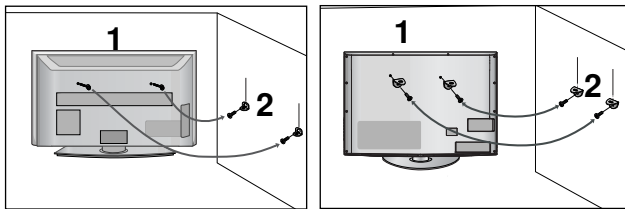

- 1 Use the eye-bolts or TV brackets/bolts to fix the product to the wall as shown in the picture. (If your TV has bolts in the eyebolts, loosen then bolts.)
* Insert the eye-bolts or TV brackets/bolts and tighten them securely in the upper holes.

- 2 Secure the wall brackets with the bolts on the wall. Match the height of the bracket that is mounted on the wall.

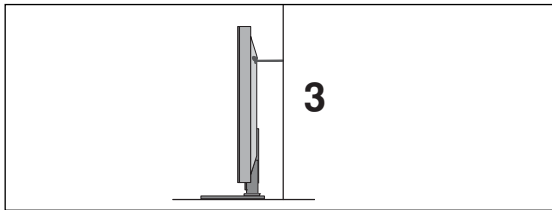

- 3 Use a sturdy rope to tie the product for alignment. It is safer to tie the rope so it becomes horizontal between the wall and the product.

! NOTE

- ▶ When moving the TV undo the cords first.
- ▶ Use a platform or cabinet strong and large enough to support the size and weight of the TV.
- ▶ To use the TV safely make sure that the height of the bracket on the wall and on the TV is the same.

SWIVEL STAND

(Except for 19/22LH20**, 19/22LU40**, 19/22/26LU50**)

- Image shown may differ from your TV. After installing the TV, you can adjust the TV set manually to the left or right direction by 20 degrees to suit your viewing position.

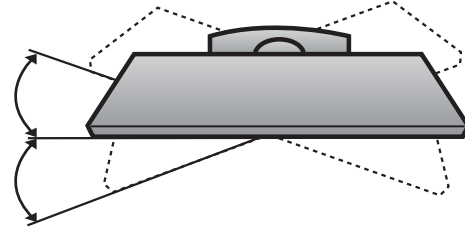

TO USE THE STAND REAR COVER (Only 37/42/47LH70**)

- Image shown may differ from your TV. Install the **STAND REAR COVER** as shown.

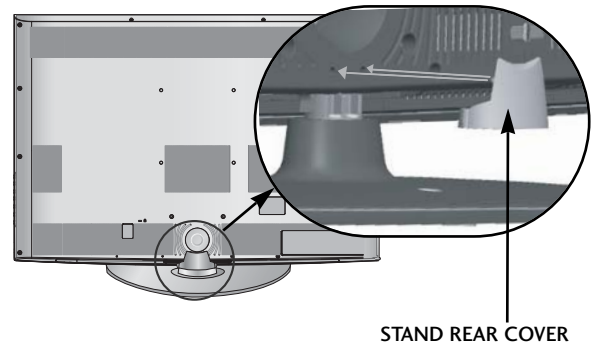

Grip the knob in your fingers and pull it.

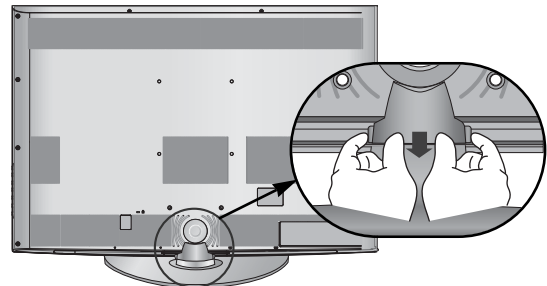

BACK COVER FOR WIRE ARRANGEMENT

■ Image shown may differ from your TV.

LCD TV Models : 19/22LH20**

- 1 Connect the cables as necessary.
To connect additional equipment, see the **EXTERNAL EQUIPMENT SETUP** section.

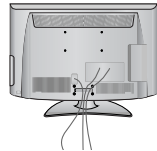

- 2 Install the **CABLE MANAGEMENT CLIP** as shown.

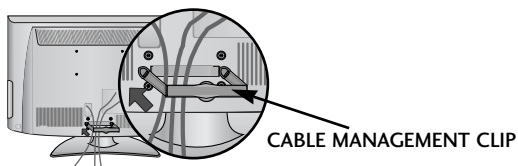

- 3 Fit the **CABLE MANAGEMENT CLIP** as shown.

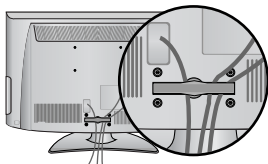

How to remove the cable management clip (LCD TV Models : 19/22LH20**)

Hold the **CABLE MANAGEMENT CLIP** with both hands and pull it backward.

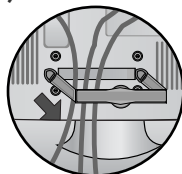

! NOTE

- ▶ Do not use the **CABLE MANAGEMENT CLIP** to lift the TV.
- If the TV is dropped, you may be injured or the TV may be damaged.

LCD TV Models : 32/37/42LF25**, 32/37/42LG21**, 26/32/37/42LH20**, 32/37/42/47LH30**, 32/37/42/47LH40**, 32/37/42/47LH49**, 32/37/42/47LH50**

- 1 Connect the cables as necessary.
To connect additional equipment, see the **EXTERNAL EQUIPMENT SETUP** section.

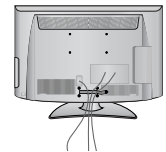

- 2 Open the **CABLE MANAGEMENT CLIP** as shown.

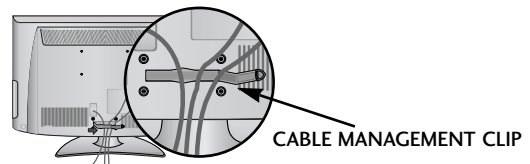

- 3 Fit the **CABLE MANAGEMENT CLIP** as shown.

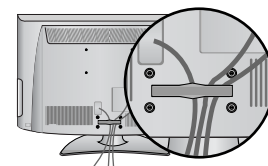

LCD TV Models : 19/22LU40**, 19/22/26LU50**

After Connecting the cables as necessary, install **CABLE HOLDER** as shown and bundle the cables.

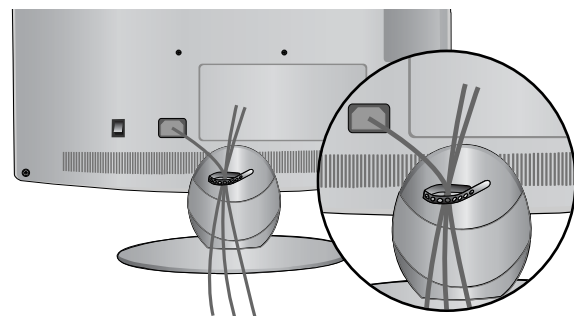

PREPARATION

LCD TV Models : 32/37/42/47LH70**

- 1 Align the hole with the tab on the **CABLE MANAGEMENT CLIP**. Turn the **CABLE MANAGEMENT CLIP** as shown. Note : that excessive force might cause damage to the product when using Cable Management clip.

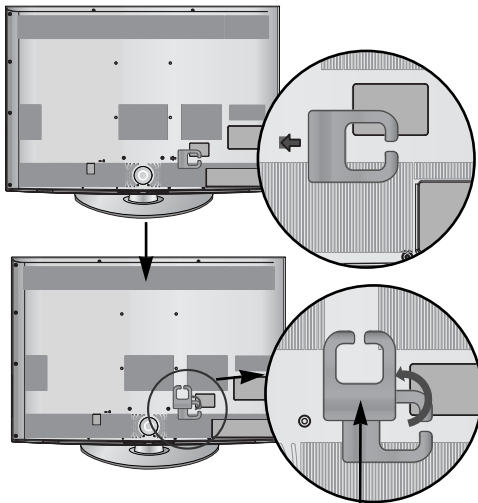

CABLE MANAGEMENT CLIP

- 2 Connect the cables as necessary. To connect additional equipment, see the **External equipment Setup** section.

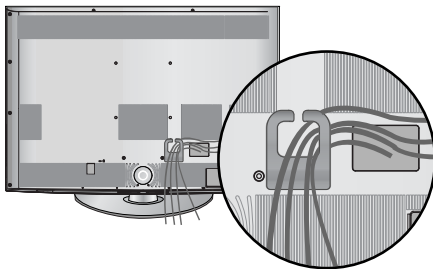

How to secure the power cable

(Only 32/37/42/47LH70**)

- 1 Secure the power cable with the **PROTECTIVE BRACKET** and the bolt as shown. It will help prevent the power cable from being removed by accident.

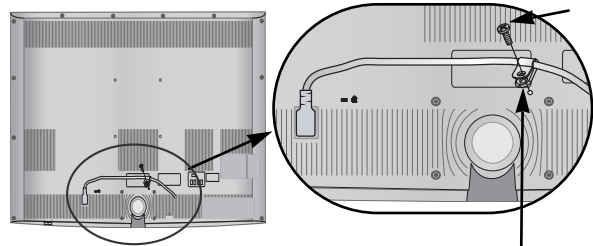

PROTECTIVE BRACKET

! NOTE

- ▶ Do not use the **CABLE MANAGEMENT CLIP** to lift the TV.
 - If the TV is dropped, you may be injured or the TV may be damaged.

Installing Batteries

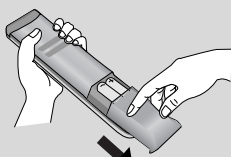

- Open the battery compartment cover on the back and install the batteries matching correct polarity (+with +,-with -).
- Install two 1.5V AAA batteries. Do not mix old or used batteries with new ones.
- Close cover.

Use of ferrite core (This feature is not available for all models.)

Ferrite core can be used to reduce the electromagnetic wave when connecting the power cord.

The closer the location of the ferrite core to the power plug, the better it is.

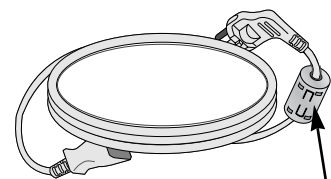

Install the power plug closely.

NOT USING THE DESK-TYPE STAND

(Except for 19/22LU40**, 19/22/26LU50**)

■ Image shown may differ from your TV.

When installing the wall-mounted unit, use the protection cover.

Only 32/37/42/47LH70**

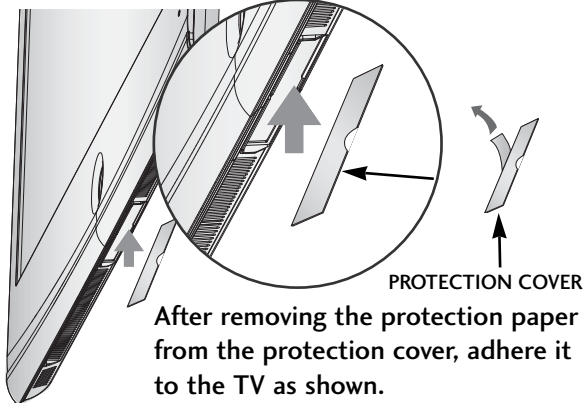

Only 26/32/37/42LH20**,
32/37/42/47LH30**, 32/37/42/47LH40**,
32/37/42/47LH49**, 32/37/42/47LH50**

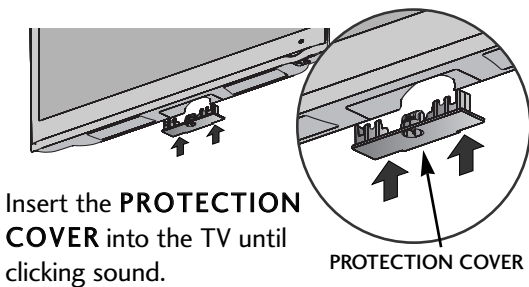

Only 32/37/42LF25**, 32/37/42LG21**

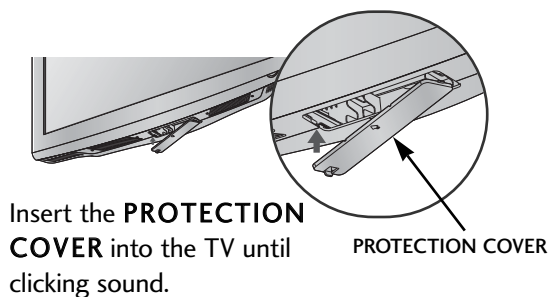

Only 19/22LH20**

- 1 Carefully place the TV screen side down on a cushioned surface to protect the screen from damage.

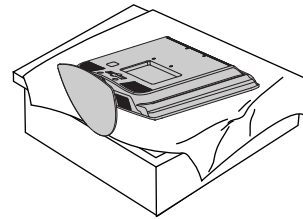

- 2 Loosen the bolts from TV.

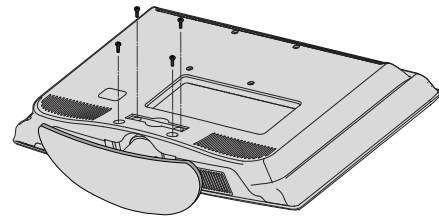

- 3 Detach the stand from TV.

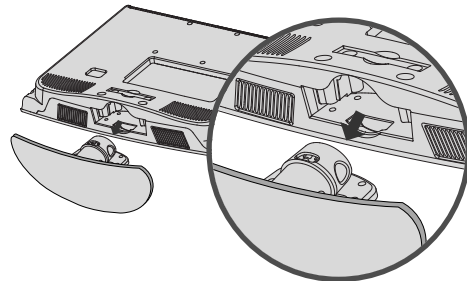

- 4 Insert the **Protection Cover** into the TV.

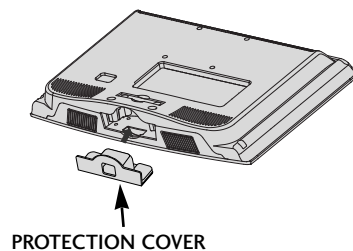

- 5 Fix the 4 bolts securely using the holes in the back of the TV.

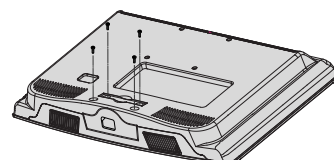

PREPARATION

- The TV can be installed in various ways such as on a wall, or on a desktop etc.
- The TV is designed to be mounted horizontally.

EARTHING

Ensure that you connect the earth wire to prevent possible electric shock. If grounding methods are not possible, have a qualified electrician install a separate circuit breaker.

Do not try to earth the TV by connecting it to telephone wires, lightning rods or gas pipes.

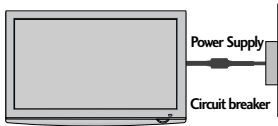

WALL MOUNT: HORIZONTAL INSTALLATION

- We recommend the use of a LG Brand wall mounting bracket when mounting the TV to a wall.
- We recommend that you purchase a wall mounting bracket which supports VESA standard.
- LG recommends that wall mounting be performed by a qualified professional installer.
- First you connect the USB extension cable to the USB IN terminal, and then hang it on the wall. (Only 32/37/42/47LH70**)

NOTE

- ▶ Should install wall mount on a solid wall perpendicular to the floor.
- ▶ Should use a special wall mount, if you want to install it to ceiling or slanted wall.
- ▶ The surface that wall mount is to be mounted on should be of sufficient strength to support the weight of TV set; e.g. concrete, natural rock, brick and hollow block.
- ▶ Installing screw type and length depends on the wall mount used. Further information, refer to the instructions included with the mount.
- ▶ LG is not liable for any accidents or damage to property or TV due to incorrect installation:
 - Where a non-compliant VESA wall mount is used.
 - Incorrect fastening of screws to surface which may cause TV to fall and cause personal injury.
 - Not following the recommended Installation method.

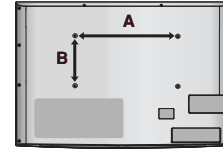
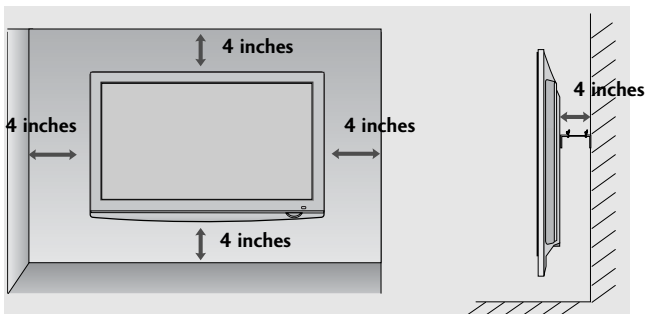

Model	VESA (A * B)	Standard Screw	Quantity
19/22LU40**	100 * 100	M4	4
19/22LU50**	100 * 100	M4	4
26LU50**	200 * 100	M4	4
32LF25**	200 * 100	M4	4
37/42LF25**	200 * 200	M6	4
32LG21**	200 * 100	M4	4
37/42LG21**	200 * 200	M6	4
19/22LH20**	100 * 100	M4	4
26/32LH20**	200 * 100	M4	4
37/42LH20**	200 * 200	M6	4
32LH30**	200 * 100	M4	4
37/42LH30**	200 * 200	M6	4
47LH30**	200 * 200	M6	4
32LH40**	200 * 100	M4	4
37/42/47LH40**	200 * 200	M6	4
32LH49**	200 * 100	M4	4
37/42/47LH49**	200 * 200	M6	4
32LH50**	200 * 100	M4	4
37/42/47LH50**	200 * 200	M6	4
32LH70**	200 * 100	M4	4
37/42/47LH70**	200 * 200	M6	4

Wall Mounting Bracket (Separate purchase)

RW120	RW230	AW-47LG30M
(19/22LU50** /19/22LU40** /19/22LH20**)	(26LU50**/32LF25** /32LG21**/26/32LH20**/ 32LH30**/32LH40**/ 32LH49** /32LH50**/32LH70**)	(32/37/42LF25** /32/37/42LG21** /32/37/42LH20** /32/37/42/47LH30** /32/37/42/47LH40** /32/37/42/47LH49** /32/37/42/47LH50** /32/37/42/47LH70**)

WATCHING TV /PROGRAMME CONTROL

CONNECTING YOUR UNIT

- Image shown may differ from your TV
- To connect an additional equipment, see the **External equipment Setup** section in CD Manual.

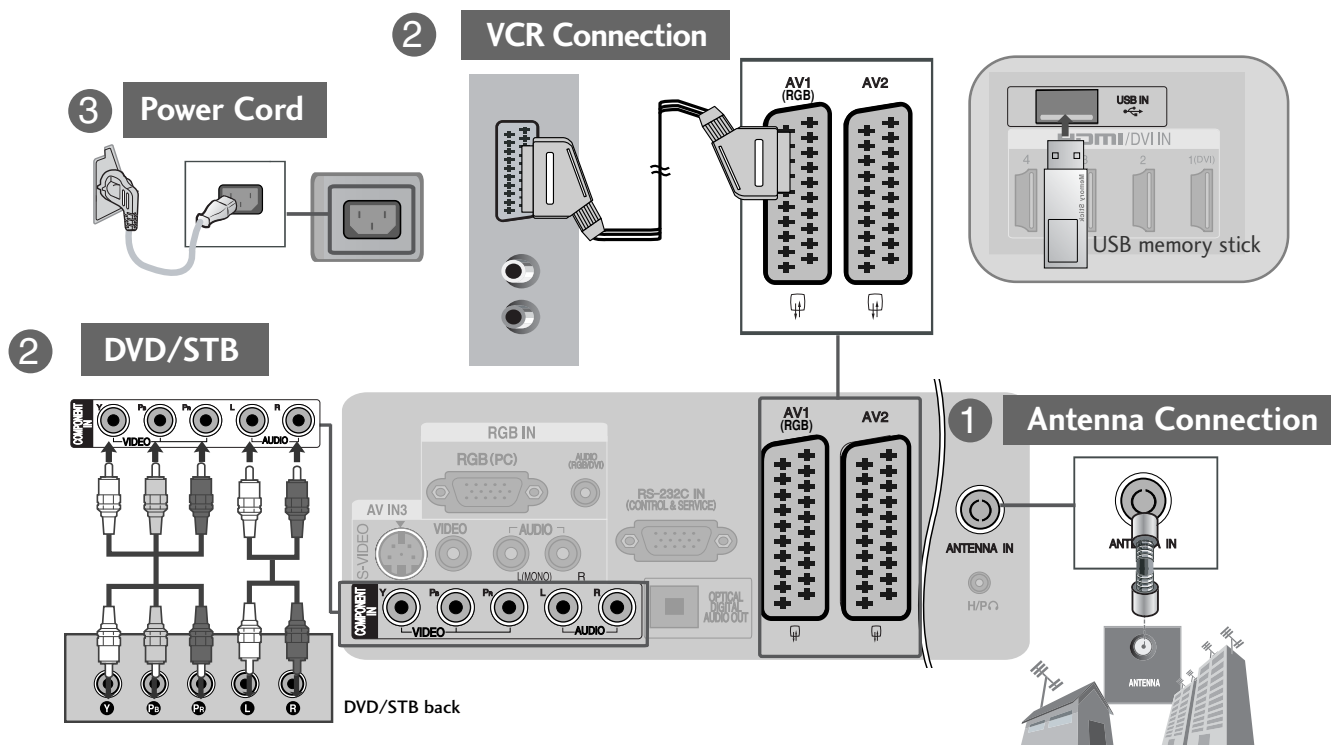

TURNING ON THE TV

- When your TV is turned on, you will be able to use its features.

- 1 Firstly, connect the power cord correctly and check the main power on the TV.
At this stage, the TV switches to standby mode.
- 2 In standby mode to turn TV on, press the **INPUT** or **P ▲ ▼** (or **P ^ v**) button on the TV or press the **POWER, INPUT, P ^ v** or **NUMBER** button on the remote control and the TV will switch on.

Initializing setup

If the OSD (On Screen Display) is displayed on the screen after turning on the TV, you can adjust the **Language, Mode Setting, Country, Auto Tuning**.

Note:

- a. If you close without completing the initial setting, the Initial Setting menu can be displayed again.
- b. Press the **RETURN** button to change the current OSD to the previous OSD.
- c. For those countries without confirmed DTV broadcasting standards, some DTV features might not work, depending on the DTV broadcasting environment.
- d. "Home Use" mode is the optimal setting for home environments, and is the TV's default mode.
- e. "Store Demo" mode is the optimal setting for store environments. If a user modifies image quality data, "Store Demo" mode initializes the product to the image quality set by us after a certain period of time.
- f. The mode (Home Use, Store Demo) can be changed by executing Mode Setting in the **OPTION** menu.

APPENDIX

MAINTENANCE

Early malfunctions can be prevented. Careful and regular cleaning can prolong the life of your new TV.
Caution: Be sure to switch the power off and unplug the power cord before you begin any cleaning.

Cleaning the Screen

- 1 A good way to keep the dust off your screen for a while is to wet a soft cloth in a mixture of lukewarm water and a little fabric softener or dish washing detergent. Wring the cloth until it is almost dry, and then use it to wipe the screen.
- 2 Ensure there is no excess water on the screen. Allow any water or dampness to evaporate before switching on.

Cleaning the Cabinet

- To remove dirt or dust, wipe the cabinet with a soft, dry, lint-free cloth.
- Do not use a wet cloth.

Extended Absence

⚠ CAUTION

- ▶ If you expect to leave your TV dormant for prolonged periods (such as a holiday), unplug the power cord to protect against possible damage from lightning or power surges.

TO VIEW THE USER'S GUIDE ON THE CD-ROM

To view the User's guide on the CD-ROM, Adobe Acrobat Reader must be installed on your PC. The "ACRORD" folder on the CD-ROM contains the installation program for Acrobat Reader. If you want to install Acrobat Reader, Open "My Computer" → Open the folder "LG" → Open the folder "ACRORD" → double-click your language.

To view the User's guide

The User's guide files are included in the supplied CD-ROM. Load the supplied CD-ROM into the CD-ROM drive of your PC. After a while, the web page of the CD-ROM will open automatically. (Windows users only) If the web page does not appear automatically, open the User's guide file directly. Open "My computer" → Open the folder "LG" → Double click the "index.htm" file.

TO VIEW THE SIMPLE MANUAL

You can easily and effectively access the TV information by viewing the simple manual on the TV.

- 1 Press the **MENU** button and then **INFO** button to enter the **Simple Manual** menu.
- 2 Press the **RETURN** button to return to normal TV viewing.

WEIGHT

MODELS		32LH40**	37LH40**	42LH40**	47LH40**
		32LH4000-ZA 32LH4010-ZD 32LH4020-ZC	37LH4000-ZA 37LH4010-ZD 37LH4020-ZC	42LH4000-ZA 42LH4010-ZD 42LH4020-ZC	47LH4000-ZA 47LH4010-ZD 47LH4020-ZC
Weight	with stand	12.7 kg / 28.0 lbs	15.8 kg / 34.9 lbs	18.9 kg / 41.7 lbs	22.2 kg / 49.0 lbs
	without stand	11.5 kg / 25.4 lbs	14.0 kg / 30.9 lbs	17.1 kg / 37.7 lbs	19.6 kg / 43.2 lbs
MODELS		32LG21**	37LG21**	42LG21**	
		32LG2100-ZA	37LG2100-ZA	42LG2100-ZA	
Weight	with stand	13.4 kg / 29.6 lbs	18.8 kg / 41.5 lbs	23.6 kg / 52.1 lbs	
	without stand	11.9 kg / 26.3 lbs	16.2 kg / 35.7 lbs	21.0 kg / 46.3 lbs	

■ The specifications shown above may be changed without prior notice for quality improvement.

MODELS		19LU50**	22LU50**	26LU50**	32LH50**
		19LU5000-ZA 19U5010-ZB 19LU5020-ZC	22LU5000-ZA 22U5010-ZB 22LU5020-ZC	26LU5000-ZA 26U5010-ZB 26LU5020-ZC	32LH5000-ZB 32LH5010-ZD 32LH5020-ZE
Weight	with stand	4.4 kg / 9.7 lbs	5.4 kg / 11.9 lbs	8.9 kg / 19.6 lbs	12.6 kg / 27.8 lbs
	without stand	3.7 kg / 8.2 lbs	4.6 kg / 10.2 lbs	7.7 kg / 17.0 lbs	11.4 kg / 25.2 lbs
MODELS		37LH50**	42LH50**	47LH50**	
		37LH5000-ZB 37LH5010-ZD 37LH5020-ZE	42LH5000-ZB 42LH5010-ZD 42LH5020-ZE	47LH5000-ZB	47LH5010-ZD 47LH5020-ZE
Weight	with stand	16.3 kg / 35.9 lbs	19.0 kg / 41.9 lbs	23.4 kg / 51.6 lbs	23.6 kg / 52.0 lbs
	without stand	14.5 kg / 32.0 lbs	17.2 kg / 37.9 lbs	20.8 kg / 45.9 lbs	20.8 kg / 45.9 lbs
MODELS		19LU40**	22LU40**	19LH20**	22LH20**
		19LU4000-ZB 19LU4010-ZC	22LU4000-ZB 22LU4010-ZC	19LH2000-ZA 19LH2010-ZB 19LH2020-ZC	22LH2000-ZA 22LH2010-ZB 22LH2020-ZC
Weight	with stand	4.4 kg / 9.7 lbs	5.5 kg / 12.1 lbs	3.8 kg / 8.4 lbs	4.8 kg / 10.6 lbs
	without stand	3.9 kg / 8.6 lbs	5.0 kg / 11.0 lbs	3.6 kg / 8.0 lbs	4.6 kg / 10.2 lbs
MODELS		26LH20**	32LH20**	37LH20**	42LH20**
		26LH2000-ZA 26LH2020-ZC 26LH2010-ZB	32LH2000-ZA 32LH2020-ZC 32LH2010-ZB	37LH2000-ZA 37LH2020-ZC 37LH2010-ZB	42LH2000-ZA 42LH2020-ZC 42LH2010-ZB
Weight	with stand	8.9 kg / 19.7 lbs	11.5 kg / 25.4 lbs	14.8 kg / 32.6 lbs	18.0 kg / 39.7 lbs
	without stand	7.8 kg / 17.2 lbs	10.3 kg / 22.7 lbs	13.0 kg / 28.7 lbs	16.2 kg / 35.7 lbs
MODELS		32LH30**	37LH30**	42LH30**	47LH30**
		32LH3000-ZA 32LH3020-ZD 32LH3010-ZB 32LH3030-ZE	37LH3000-ZA 37LH3020-ZD 37LH3010-ZB 37LH3030-ZE	42LH3000-ZA 42LH3020-ZD 42LH3010-ZB 42LH3030-ZE	47LH3000-ZA 47LH3020-ZD 47LH3010-ZB 47LH3030-ZE
Weight	with stand	12.1 kg / 26.7 lbs	14.9 kg / 32.9 lbs	18.0 kg / 39.7 lbs	22.5 kg / 49.6 lbs
	without stand	11.0 kg / 24.3 lbs	13.1 kg / 28.9 lbs	16.2 kg / 35.7 lbs	19.9 kg / 43.9 lbs
MODELS		32LH70**	37LH70**	42LH70**	47LH70**
		32LH7000-ZA 32LH7010-ZD 32LH7020-ZC 32LH7030-ZE	37LH7000-ZA 37LH7010-ZD 37LH7020-ZC 37LH7030-ZE	42LH7000-ZA 42LH7010-ZD 42LH7020-ZC 42LH7030-ZE	47LH7000-ZA 47LH7010-ZD 47LH7020-ZC 47LH7030-ZE
Weight	with stand	13.5 kg / 29.7 lbs	16.2 kg / 35.7 lbs	19.8 kg / 43.7 lbs	26.4 kg / 58.2 lbs
	without stand	11.6 kg / 25.5 lbs	14.1 kg / 31.0 lbs	17.2 kg / 37.9 lbs	22.8 kg / 50.2 lbs
MODELS		32LH49**	37LH49**	42LH49**	47LH49**
		32LH4900-ZD	37LH4900-ZD	42LH4900-ZD	47LH4900-ZD
Weight	with stand	12.7 kg / 28.0 lbs	15.8 kg / 34.9 lbs	18.9 kg / 41.7 lbs	22.2 kg / 49.0 lbs
	without stand	11.5 kg / 25.4 lbs	14.0 kg / 30.9 lbs	17.1 kg / 37.7 lbs	19.6 kg / 43.2 lbs
MODELS		32LF25**	37LF25**	42LF25**	
		32LF2500-ZA 32LF2510-ZB	37LF2500-ZA 37LF2510-ZB	42LF2500-ZA 42LF2510-ZB	
Weight	with stand	13.4 kg / 29.6 lbs	18.8 kg / 41.5 lbs	23.6 kg / 52.1 lbs	
	without stand	11.9 kg / 26.3 lbs	16.2 kg / 35.7 lbs	21.0 kg / 46.3 lbs	

■ The specifications shown above may be changed without prior notice for quality improvement.

TROUBLESHOOTING

The TV does not operate properly.

The remote control does not work

- Check to see if there is any object between the TV and the remote control causing an obstruction. Ensure you are pointing the remote control directly at the TV.
- Ensure that the batteries are installed with correct polarity (+ to +, - to -).
- Ensure that the correct remote operating mode is set : TV, STB etc.
- Install new batteries.

Power is suddenly turned off

- Is the sleep timer set?
- Check the power control settings. Has the Power supply been interrupted.
- If the TV is switched on and there is no input signal, it will switch off automatically after 15 minutes.

The video function does not work.

No picture & No sound

- Check whether the TV is switched on.
- Try another channel. The problem may be with the broadcast.
- Is the power cord inserted correctly into the mains?
- Check your antenna direction and/or location.
- Test the mains outlet by plugging another TV into the same outlet.

Picture appears slowly after switching on

- This is normal, the image is muted during the TV startup process. Please contact your service centre, if the picture has not appeared after five minutes.

No or poor colour or poor picture

- Adjust Colour in menu option.
- Allow a sufficient distance between the TV and the VCR.
- Try another channel. The problem may be with the broadcast.
- Are the video cables installed properly?
- Activate any function to restore the brightness of the picture.

Horizontal/vertical bars or picture shaking

- Check for local interference such as an electrical appliance or power tool.

Poor reception on some channels

- Station or cable channel experiencing problems, tune to another station.
- Station signal is weak, reposition the antenna to receive weaker stations.
- Check for sources of possible interference.

Lines or streaks in pictures

- Check antenna (Change the position of the antenna).

No picture when connecting HDMI

- Check that your HDMI cable is version 1.3 or higher.
If the HDMI cables don't support HDMI version 1.3, flickering or no screen display can result. Please use the latest cables that support at least HDMI version 1.3.

There is a problem with PICTURE settings.

When the user changes the picture settings, the TV automatically converts back to the initial settings after a certain period of time.

- It means that the TV is currently set to **Store Demo** mode.
To switch to **Home use** mode you should do the followings:
From the TV Menu, choose **OPTION** -> Choose **Mode Setting** -> Choose **Home use**. Now, you have completed switching to the **Home use** mode.